

IN/  
DO  
ORS

IN/  
EVOLUTION  
INNOVATION

**mobil** 

IN/  
DO  
ORS

IN/  
EVOLUTION  
INNOVATION

**|||obil** 



*What does it mean?*

/  
WHERE TECHNOLOGY  
MEETS DESIGN

DESIGN TECHNOLOGY - Innovation



/

# AMBRA

SMART LIVING

Nuove esperienze Smart e Design minimalista per un classico sempre attuale.

New smart experiences and minimalist design for a timeless classic.

Nouvelles expériences intelligentes et design minimaliste pour un classique intemporel.





# / MATT MATERIAL

DESIGN TECHNOLOGY - In progress

Un'esperienza nuova e raffinata  
che arricchisce le soluzioni di arredo

A new fine experience which  
enriches furnishing solutions

Une expérience nouvelle et raffinée  
qui enrichit les solutions d'ameublement



# / POLAR

DESIGN TECHNOLOGY - In evolution



L'eleganza e la semplicità della finitura Polar si esaltano in un interior design dedicato alla luminosità grazie al nuovo delicato pattern ed alla sua versione ortogonale.

The elegance and simplicity of Polar is intensified in a light-oriented interior design thanks to this delicate new pattern and its orthogonal version.

L'élégance et la simplicité du Polar s'intensifient dans un design intérieur orienté vers la lumière, grâce à ce nouveau motif et à sa version orthogonale.

/  
WHY ?



tecnologia  
technology  
technologie



innovazione  
innovation  
innovation



design  
design  
design



funzionalità  
functionality  
fonctionnalité



adattabilità  
adaptability  
adaptabilité



high-tech  
high-tech  
high-tech



affidabilità  
reliability  
fiabilité



ricerca estetica  
aesthetic research  
recherche esthétique



ampia gamma  
broad selection  
large sélection

Because it's design technology!



**Touch.** La texture delle nostre superfici conferisce delle proprietà tattili uniche ed esclusive al nostro prodotto.

**Touch.** The texture of our surfaces gives unique and exclusive tactile properties to our products.

**Touch.** La texture des surfaces confère à nos produits des propriétés tactiles uniques et exclusives.



**Adattabilità.** Gli avanzati processi di produzione di Mobil3 consentono di ottenere pannelli con altezze maggiorate e stipiti adattabili su più spessori di muro.

**Adaptability.** Advanced manufacturing processes allow Mobil3 to produce higher panels and frame suitable for different wall thicknesses.

**Adaptabilité.** Le processus de fabrication avancé permet à Mobil3 de produire vantaux plus hauts et chambranle adaptés à différentes épaisseurs de murs.



**Ricerca e innovazione.** Le finiture sono il fiore all'occhiello dell'azienda: la nostra ampia gamma viene costantemente rinnovata grazie ad un assiduo e attivo processo di ricerca e sviluppo.

**Research and Innovation.** Finishes are the company's crowning point: our wide selection is constantly renovated thanks to an active and regular research and development process.

**Recherche et Innovation.** Les finitions sont le couronnement de l'entreprise: notre large sélection est constamment rénové grâce à un processus de recherche et développement actif et régulier.



**Affidabilità.** La fiducia del cliente è il nostro obiettivo, forti della nostra esperienza e puntualità.

**Reliability.** Our goal is clients' trust, on the strength of our experience and accuracy.

**Fiabilità.** Notre objectif est la confiance des clients, grâce à notre expérience et ponctualité.



**Ambiente.** I nostri processi produttivi sono progettati nel rispetto per l'ambiente, per un impatto ecosostenibile a 360°.

**Environment.** Our manufacturing process is thought to be environmentally friendly.

**Environnement.** Notre processus de fabrication est pensé pour être écologique.



**Finiture innovative.** Materiali innovativi, design e qualità tecnologica.

**Innovative Finishes.** Design finishes made with technologically advanced, high quality materials.

**Finitions Innovatives.** Finitions fabriquées avec des matériaux de haute qualité et technologiquement avancés.



/  
COLLECTION  
**INDEX**



**/ 86**  
TRASPARENZE  
Transparency  
Transparence



**/ 94**  
INVISIBILE  
Invisible  
Invisible



**/ 104**  
SOLUZIONI DI APERTURA  
Opening solutions  
Solutions d'ouverture



**/ 16**  
DESIGN  
COLLECTION



**/ 50**  
CONTEMPORANEO  
COLLECTION



**/ 118**  
VETRI  
Glasses  
Verres



**/ 128**  
MANIGLIE  
Handles  
Poignée

/  
COLLECTION

# DESIGN

DIVERSE FINITURE NE ESALTANO LA MATERICITÀ E L'ELEGANZA, SPRIGIONANDO TUTTA LA MAGNIFICENZA NELLE SOLUZIONI D'ARREDO CHE DEFINISCONO ED ESALTANO LO SPAZIO.

VARIOUS FINISHES INTENSIFY THE MATERIALITY AND ELEGANCE OF DOORS, RELEASING MAGNIFICENCE IN FURNISHING SOLUTIONS WHICH DEFINE AND ENHANCE SPACES.

DIFFÉRENTES FINITIONS EN FONT RESSORTIR LA TEXTURE ET L'ÉLÉGANCE, EMBELLISSANT AINSI TOUTES LES SOLUTIONS D'AMEUBLEMENT QUI DÉFINISSENT ET EXALTENT LES ESPACES.



**/ 18**  
MATERIA



**/ 26**  
COLOR



**/ 30**  
REAL WOOD

DETTAGLI **TECNICI** A PAG. 46-47 / TECHNICAL DETAILS PAGES 46-47 / DÉTAILS TECHNIQUES PAGES 46-47

**mobili**

## SOLUZIONI POSSIBILI / POSSIBLE SOLUTIONS / SOLUTIONS POSSIBLES

### Porta liscia / Flat door / Portes lisses

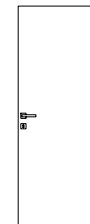

### Porte con inserti / Doors with inserts / Portes avec inserts

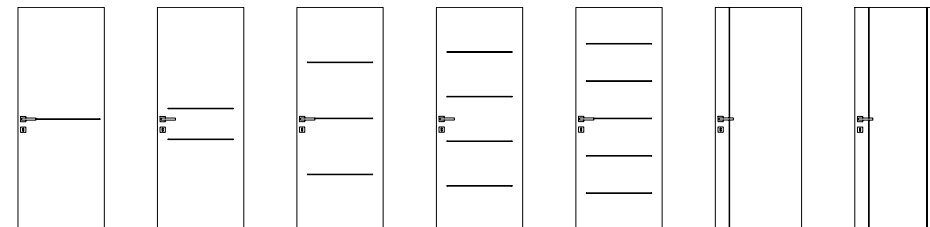

### Porte a vetro / Doors with glass / Portes vitrées

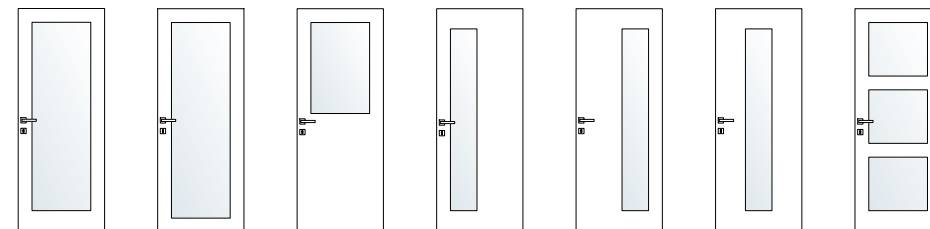

# / MATERIA

CON LE FINITURE MATERIA SI APRE UN NUOVO CAPITOLO DEDICATO ALLA MATERICITÀ DELLE SUPERFICI; UN'ESPERIENZA NUOVA RAFFINATA CHE ARRICCHISCE LE SOLUZIONI D'ARREDO.

WE ARE STARTING A NEW CHAPTER DEDICATED TO SURFACES' MATERIALITY WITH MATERIA FINISHES; A NEW FINE EXPERIENCE WHICH ENRICHES FURNISHING SOLUTIONS.

NOUS COMMENÇONS UN NOUVEAU CHAPITRE DÉDIÉ À LA MATÉRIALITÉ DES SURFACES AVEC LES FINITIONS MATERIA. UNE NOUVELLE EXPÉRIENCE QUI ENRICHIT LES SOLUTIONS D'AMEUBLEMENT.

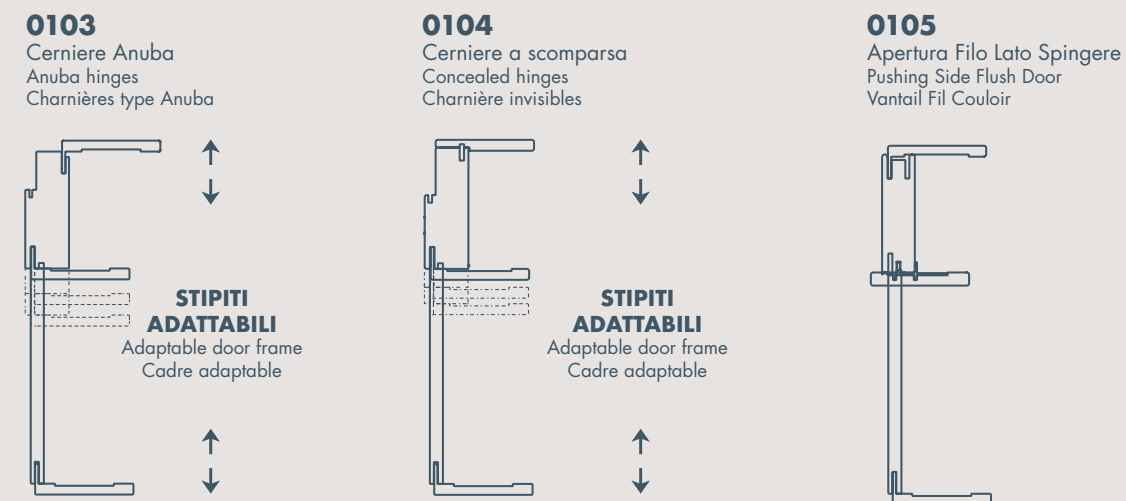

Per muro 11, 13 e 15 cm realizziamo lo stipite in pezzo unico.  
Per muri più spessi forniamo il Kit allargamento tagliato a misura.

We provide a single piece door frame for wall thicknesses of 11, 13, and 15 cm.  
We provide cut-to-size extensions for thicker walls.

Nous fournissons des cadres en pièce unique pour épaisseurs de murs de 11, 13 et 15 cm.  
Nous fournissons des élargissement sur mesure pour des murs plus épais.

## MATERIA BLANC

MATERIA BLANC  
MATERIA BLANC



## MATERIA GRIS

MATERIA GRIS  
MATERIA GRIS



## MATERIA BEIGE

MATERIA BEIGE  
MATERIA BEIGE





/  
MATERIA  
**BLANC**

MOD.  
**M3-DESIGN01**

STIPITE / FRAME / CHAMBRANLE  
**M3-0104**

FINITURA / FINISH / FINITION  
**BLANC**



/  
MATERIA  
**BEIGE**

MOD.  
**M3-DESIGN01**

STIPITE / FRAME / CHAMBRANLE  
**M3-0104**

FINITURA / FINISH / FINITION  
**BEIGE**

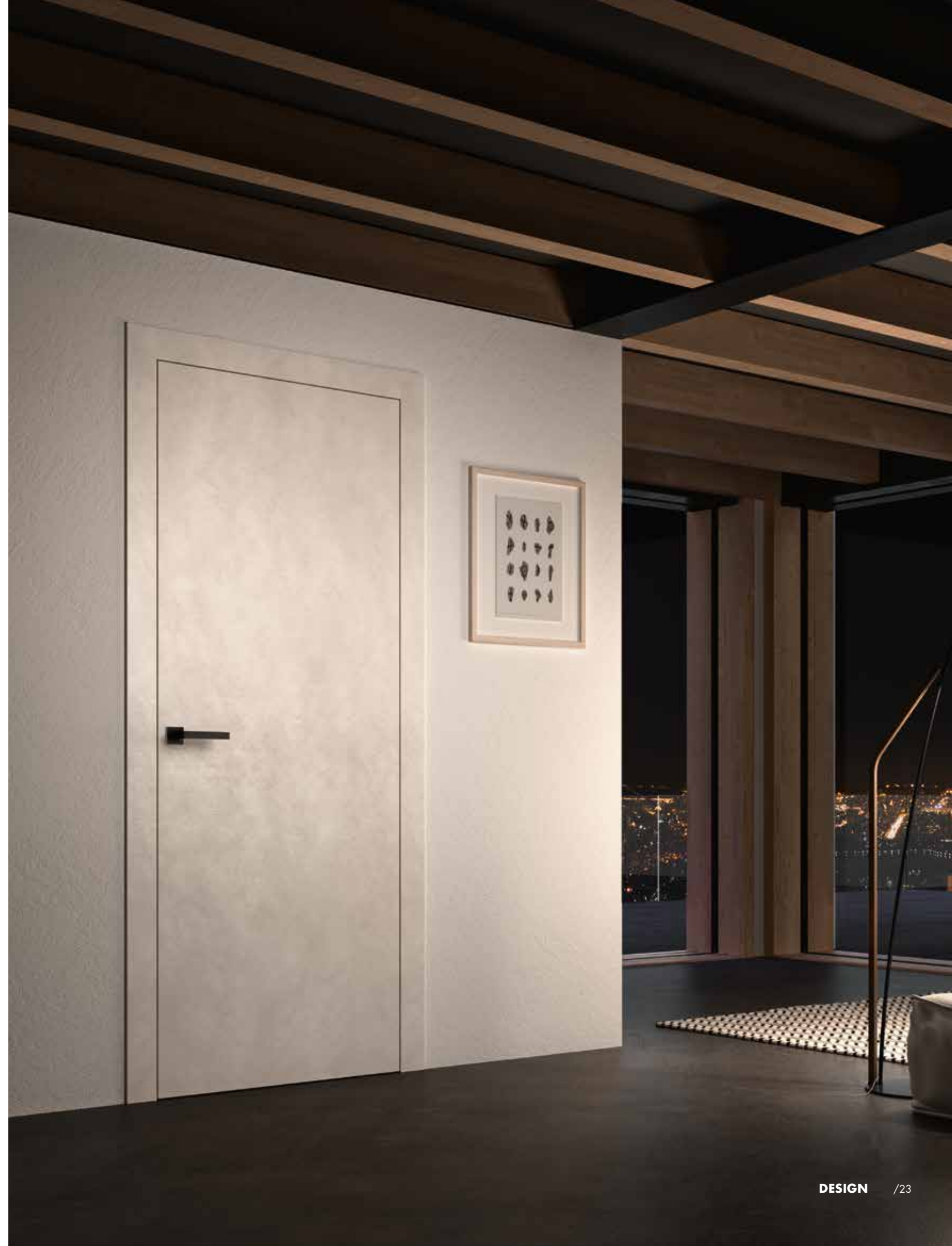



/  
MATERIA  
**GRIS**

MOD.  
**M3-DESIGN01**

STIPITE / FRAME / CHAMBRANLE  
**M3-0104**

FINITURA / FINISH / FINITION  
**GRIS**



# / COLOR

COLORI PASTELLO RIVISITATI IN UN DESIGN MODERNO E SENZA TEMPO PER LA NUOVA COLLEZIONE COLOR.

PASTEL COLOURS REINTERPRETED IN A MODERN AND TIMELESS DESIGN FOR THE NEW COLOR COLLECTION.

LES NUANCES PASTEL RÉINTERPRÉTÉES DANS UN DESIGN MODERNE ET INTEMPOREL POUR LA NOUVELLE COLLECTION COLOR.

## 0104

Cerniere a scomparsa  
Concealed hinges  
Charnière invisibles

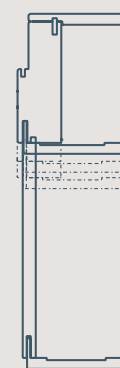

**STIPITI  
ADATTABILI**  
Adaptable door frame  
Cadre adaptable

## 0105

Apertura Filo Lato Spingere  
Pushing Side Flush Door  
Vantail Fil Couloir

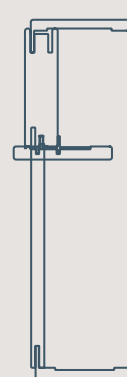

Per muro 11, 13 e 15 cm realizziamo lo stipite in pezzo unico.  
Per muri più spessi forniamo il Kit allargamento tagliato a misura.

We provide a single piece door frame for wall thicknesses of 11, 13, and 15 cm.  
We provide cut-to-size extensions for thicker walls.

Nous fournissons des cadres en pièce unique pour épaisseurs de murs de 11, 13 et 15 cm.  
Nous fournissons des élargissement sur mesure pour des murs plus épais.

## AMBRA

AMBRA  
AMBRA

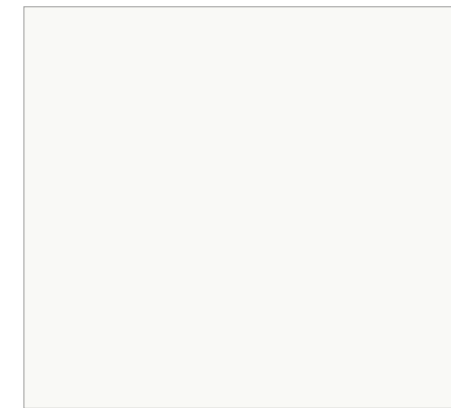



/  
COLOR  
**AMBRA**

MOD.  
**M3DESIGN01**

STIPITE / FRAME / CHAMBRANLE  
**M3-0104**

FINITURA / FINISH / FINITION  
**AMBRA**





# / REAL WOOD

UNA SOLUZIONE PER  
AMBIENTI AMPI E LUMINOSI

THE SOLUTION FOR WIDE  
AND BRIGHT INDOOR SPACES

UNE SOLUTION POUR ENVIRONNEMENTS  
LARGES ET LUMINEUX

## 0103

Cerniere Anuba  
Anuba hinges  
Charnières type Anuba

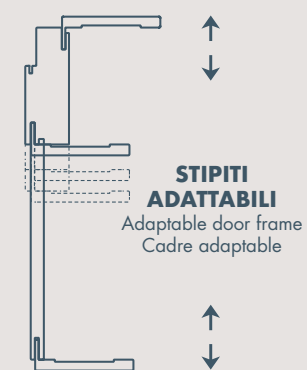

## 0104

Cerniere a scomparsa  
Concealed hinges  
Charnière invisibles

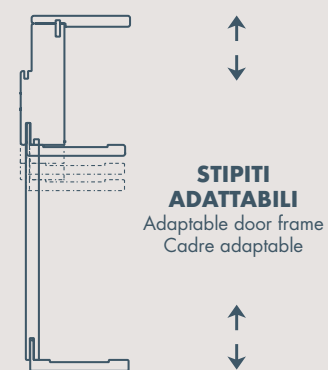

## 0105

Apertura Filo Lato Spingere  
Pushing Side Flush Door  
Vantail Fil Couloir

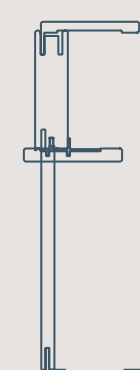

Per muro 11, 13 e 15 cm realizziamo lo stipite in pezzo unico.  
Per muri più spessi forniamo il Kit allargamento tagliato a misura.

We provide a single piece door frame for wall thicknesses of 11, 13, and 15 cm.  
We provide cut-to-size extensions for thicker walls.

Nous fournissons des cadres en pièce unique pour épaisseurs de murs de 11, 13 et 15 cm.  
Nous fournissons des élargissement sur mesure pour des murs plus épais.

## CANAPA

CANAPA  
CANAPA



## CANAPA ORTHOGONAL

CANAPA ORTHOGONAL  
CANAPA ORTHOGONAL



## CORDA

CORDA  
CORDA



## DAKOTA

DAKOTA  
DAKOTA



## SMOKE

SMOKE  
SMOKE



## NORDIC

NORDIC  
NORDIC



## POLAR

POLAR  
POLAR



## POLAR ORTHOGONAL

POLAR ORTHOGONAL  
POLAR ORTHOGONAL

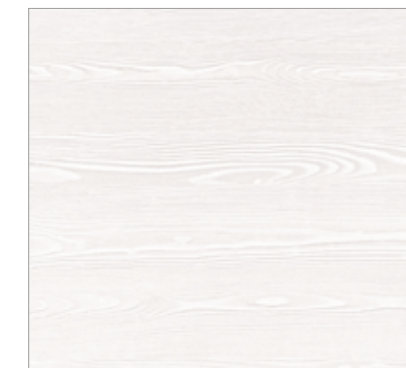



/  
REAL WOOD  
**CANAPA**

MOD.  
**M3-DESIGN01**

STIPITE / FRAME / CHAMBRANLE  
**M3-0104**

FINITURA / FINISH / FINITION  
**CANAPA**





/  
REAL WOOD  
**CANAPA ORTHOGONAL**

MOD.  
**M3-DESIGN01**

STIPITE / FRAME / CHAMBRANLE  
**M3-0104**

FINITURA / FINISH / FINITION  
**CANAPA ORTHOGONAL**





/  
REAL WOOD  
**CORDA**

MOD.  
**M3-DESIGN01**

STIPITE / FRAME / CHAMBRANLE  
**M3-0103**

FINITURA / FINISH / FINITION  
**CORDA**



/  
REAL WOOD  
**DAKOTA**

MOD.  
**M3-DESIGN01**

STIPITE / FRAME / CHAMBRANLE  
**M3-0104**

FINITURA / FINISH / FINITION  
**DAKOTA**



/  
REAL  
WOOD  
NORDIC

MOD.  
M3-DESIGN01

STIPITE / FRAME / CHAMBRANLE  
M3-0104

FINITURA / FINISH / FINITION  
NORDIC



/  
REAL WOOD  
NORDIC

MOD.  
M3-DESIGN01

STIPITE / FRAME / CHAMBRANLE  
M3-0105

FINITURA / FINISH / FINITION  
NORDIC





# / REAL WOOD SMOKE

MOD.  
M3-DESIGN01

SCORREVOLE ESTERNO MURO TIPO "F"  
EXTERNAL SLIDING "F" VERSION  
EN APPLIQUE TYPE "F"

FINITURA / FINISH / FINITION  
SMOKE



/  
REAL WOOD  
**POLAR**

MOD.  
**M3-DESIGN01**

STIPITE / FRAME / CHAMBRANLE  
**M3-0104**

FINITURA / FINISH / FINITION  
**POLAR**





/  
REAL WOOD  
**POLAR ORTHOGONAL**

MOD.  
**M3-DESIGN01**

STIPITE / FRAME / CHAMBRANLE  
**M3-0104**

FINITURA / FINISH / FINITION  
**POLAR ORTHOGONAL**



## DETTAGLI TECNICI "DESIGN"

TECHNICAL DETAILS "DESIGN" / DÉTAILS TECHNIQUES "DESIGN"

### STIPITE M3-0103

FRAME M3-0103  
CHAMBRANLE M3-0103

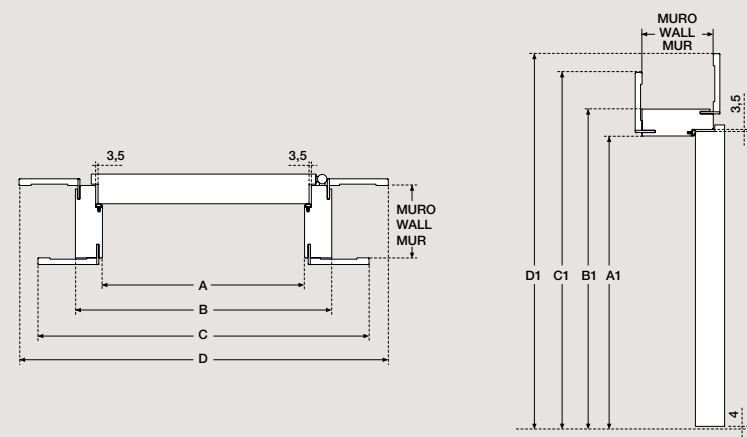

A / A1	B	C	D	B1	C1	D1
Passaggio luce Net dimension Passage libre	Misura esterno telaio Rough opening Mesure hors cadre	Misura esterno coprifilo 1 External casing 1 À l'extérieur du couvre-joint1	Misura esterno coprifilo External casing À l'extérieur du couvre-joint	Misura esterno telaio Rough opening Mesure hors cadre	Misura esterno coprifilo 1 External casing 1 À l'extérieur du couvre-joint1	Misura esterno coprifilo External casing À l'extérieur du couvre-joint
-	<b>A</b> +80 mm	<b>A</b> +190 mm	<b>A</b> +248 mm	<b>A1</b> +40 mm	<b>A1</b> +95 mm	<b>A1</b> +124 mm

### STIPITE M3-0104

FRAME M3-0104  
CHAMBRANLE M3-0104

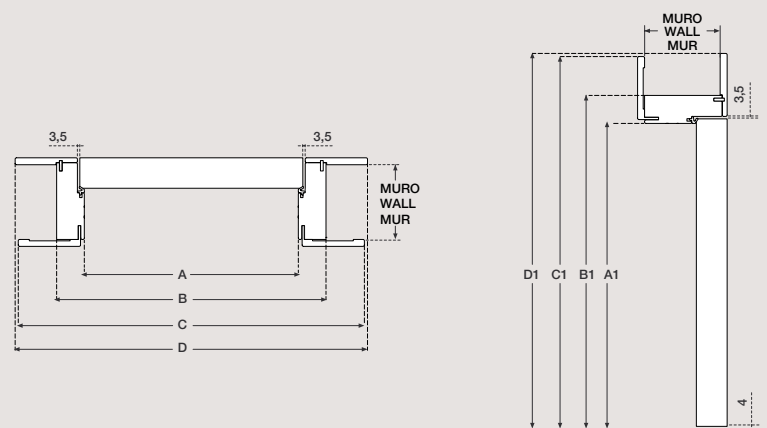

A / A1	B	C	D	B1	C1	D1
Passaggio luce Net dimension Passage libre	Misura esterno telaio Rough opening Mesure hors cadre	Misura esterno coprifilo 1 External casing 1 À l'extérieur du couvre-joint1	Misura esterno coprifilo External casing À l'extérieur du couvre-joint	Misura esterno telaio Rough opening Mesure hors cadre	Misura esterno coprifilo 1 External casing 1 À l'extérieur du couvre-joint1	Misura esterno coprifilo External casing À l'extérieur du couvre-joint
-	<b>A</b> +80 mm	<b>A</b> +190 mm	<b>A</b> +200 mm	<b>A1</b> +40 mm	<b>A1</b> +95 mm	<b>A1</b> +100 mm

## DETTAGLI TECNICI "DESIGN"

TECHNICAL DETAILS "DESIGN" / DÉTAILS TECHNIQUES "DESIGN"

### STIPITE M3-0105

FRAME M3-0105  
CHAMBRANLE M3-0105

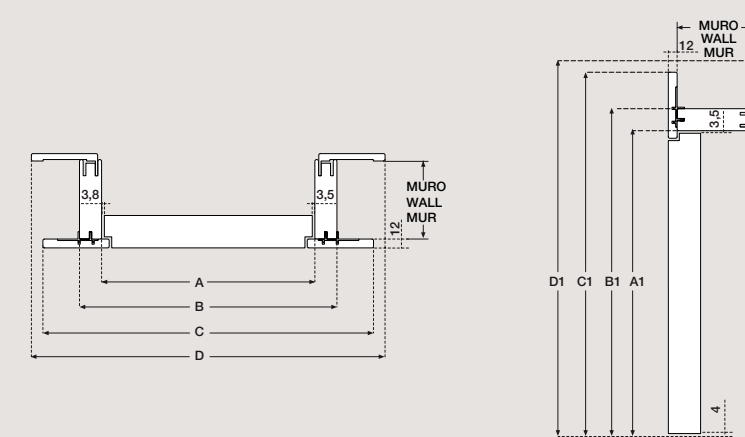

A / A1	B	C	D	B1	C1	D1
Passaggio luce Net dimension Passage libre	Misura esterno telaio Rough opening Mesure hors cadre	Misura esterno coprifilo 1 External casing 1 À l'extérieur du couvre-joint1	Misura esterno coprifilo External casing À l'extérieur du couvre-joint	Misura esterno telaio Rough opening Mesure hors cadre	Misura esterno coprifilo 1 External casing 1 À l'extérieur du couvre-joint1	Misura esterno coprifilo External casing À l'extérieur du couvre-joint
-	<b>A</b> +80 mm	<b>A</b> +180 mm	<b>A</b> +190 mm	<b>A1</b> +40 mm	<b>A1</b> +90 mm	<b>A1</b> +105 mm

### CERNIERA ANUBA ANUBA HINGES PAUMELLES ANUBA



### CERNIERA A SCOMPARSA K8000 CONCEALED HINGES K8000 CHARNIÈRES INVISIBLES K8000



### CERNIERA A SCOMPARSA K8060 CONCEALED HINGES K8060 CHARNIÈRES INVISIBLES K8060



/  
COLLECTION

# CONTEMPORANEO

Contemporary  
Contemporaine

PORTE CHE INCONTRANO IL GUSTO DI CHI È ALLA RICERCA DI MODERNITÀ/CONTEMPORANEITÀ. AMPIA VARIETÀ DI MODELLI IN TANTI COLORI E FINITURE.

DOORS THAT MEET THE TASTE OF THOSE LOOKING FOR MODERN AND CONTEMPORARY SOLUTIONS WITH A WIDE VARIETY OF MODELS AND COLOURS.

PORTES QUE RENCONTRENT LE GOÛT DE CEUX QUI SONT À LA RECHERCHE DE LA MODERNITÉ ET CONTEMPORANÉITÉ.



/ 52  
TRAMA

DETTAGLI **TECNICI** A PAG. 84-85 / TECHNICAL DETAILS PAGES 84-85 / DÉTAILS TECHNIQUES PAGES 84-85

**mobili**

## SOLUZIONI POSSIBILI / POSSIBLE SOLUTIONS / SOLUTIONS POSSIBLES

### Porta liscia / Flat door / Portes lisses

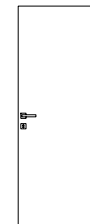

### Porte con inserti / Doors with inserts / Portes avec inserts

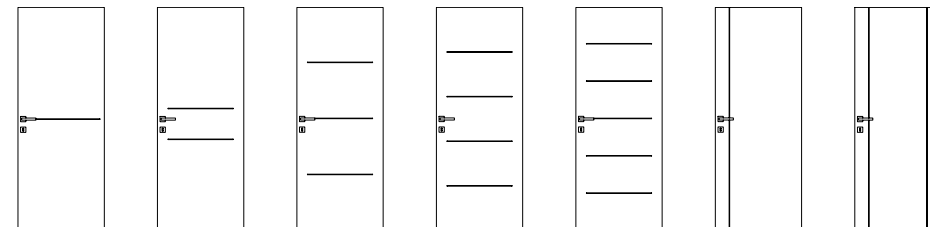

### Porte a vetro / Doors with glass / Portes vitrées

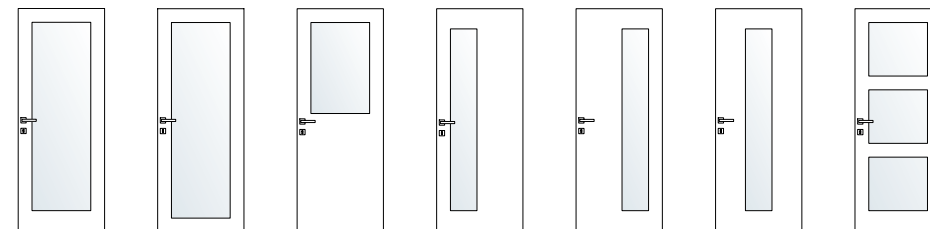

# / TRAMA

GEOMETRIE CHE SOTTOLINEANO  
LE SOLUZIONI D'ARREDO

GEOMETRIES THAT HIGHLIGHT  
FURNISHING SOLUTIONS

DES GÉOMÉTRIES QUI SOULIGNENT  
LES SOLUTIONS D'AMEUBLEMENT

## 0100

Cerniere Anuba  
Anuba hinges  
Charnières type Anuba

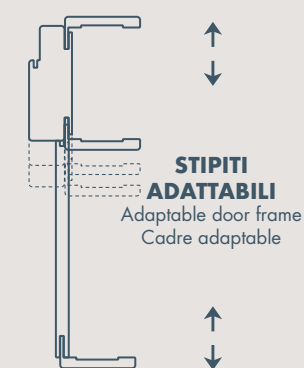

## 0102-NEW

Cerniere a scomparsa  
Concealed hinges  
Charnière invisibles

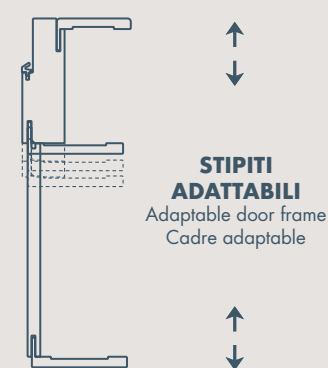

Per muro 11, 13 e 15 cm realizziamo lo stipite in pezzo unico.  
Per muri più spessi forniamo il Kit allargamento tagliato a misura.

We provide a single piece door frame for wall thicknesses of 11, 13, and 15 cm.  
We provide cut-to-size extensions for thicker walls.

Nous fournissons des cadres en pièce unique pour épaisseurs de murs de 11, 13 et 15 cm.  
Nous fournissons des élargissement sur mesure pour des murs plus épais.

**BIANCO B011**  
WHITE B011  
BLANC B011

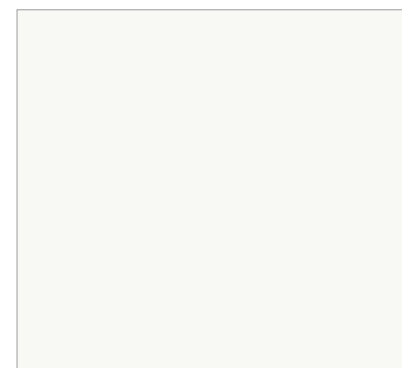

**PANNA B003**  
CREAM B003  
CRÈME B003

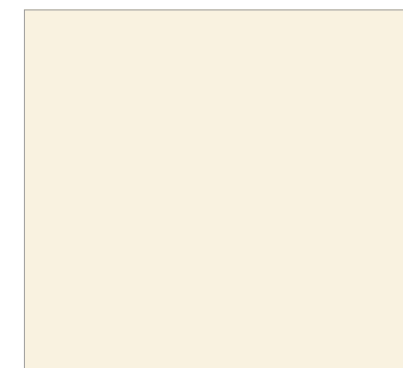

**NOCE LD57**  
WALNUT LD57  
NOYER LD57



**NOCE 840**  
WALNUT 840  
NOYER 840



**ROVERE LG23**  
OAK LG23  
CHÊNE LG23



**CILIEGIO LG69**  
CHERRY LG69  
CERISIER LG69



**MATRIX BIANCO B011**  
MATRIX WHITE B011  
MATRIX BLANC B011



**PALISSANDRO BIANCO 2302**  
WHITE ROSEWOOD 2302  
PALISSANDRE BLANC 2302



**FRASSINO B073**  
ASH B073  
FRÊNE B073

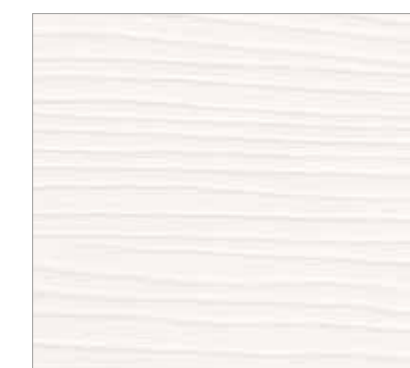

**LARICE GRIGIO 1105**  
GREY LARCH 1105  
MÉLÈZE GRIS 1105



**GRANO LM36**  
WHEAT LM36  
BLÉ LM36



**PALISSANDRO GRIGIO LK55**  
GREY ROSEWOOD LK55  
PALISSANDRE GRIS LK55







/  
TRAMA  
**MATRIX**

MOD.  
**M3-1201**

STIPITE / FRAME / CHAMBRANLE  
**M3-0100**

FINITURA / FINISH / FINITION  
**MATRIX**





/  
TRAMA  
**LARICE**

MOD.  
**M3-1000**

STIPITE / FRAME / CHAMBRANLE  
**M3-0102 NEW**

FINITURA / FINISH / FINITION  
**LARICE GRIGIO / GREY LARCH / MÉLÈZE GRIS  
1105**





/  
TRAMA  
**GRANO**

MOD.  
**M3-1000**

STIPITE / FRAME / CHAMBRANLE  
**M3-0102 NEW**

FINITURA / FINISH / FINITION  
**GRANO / WHEAT / BLÉ**  
LM36

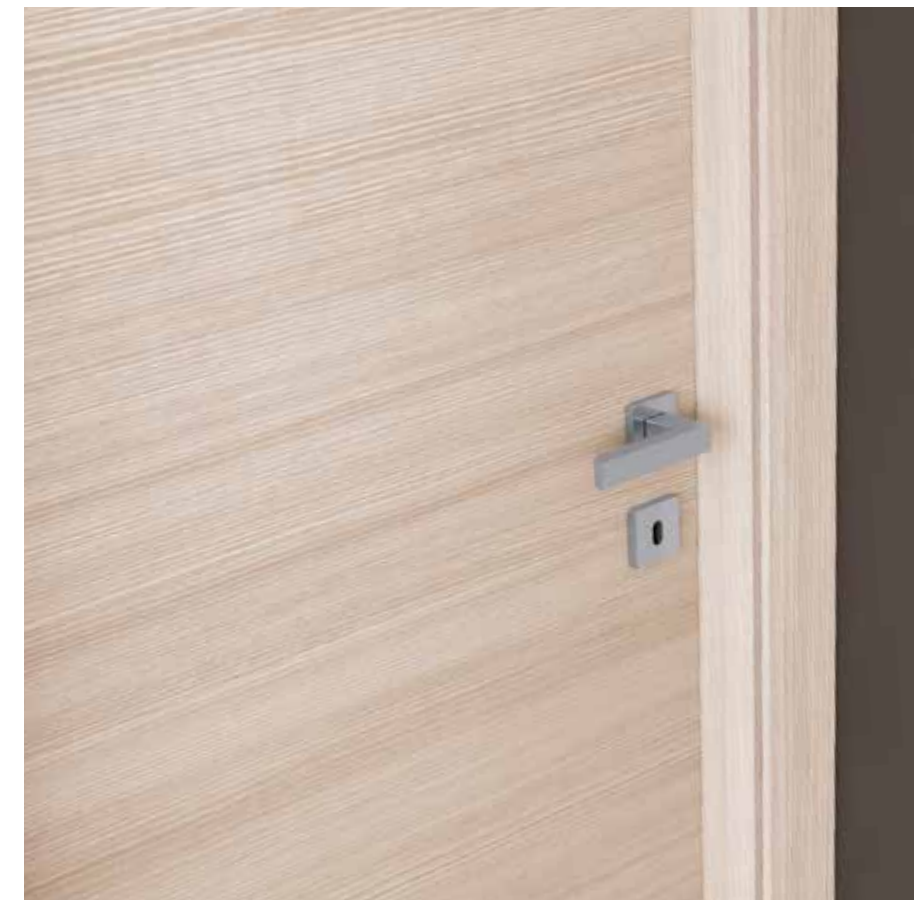



/  
TRAMA  
**MATRIX**

MOD.  
**M3-1000**

STIPITE / FRAME / CHAMBRANLE  
**M3-0102 NEW**

FINITURA / FINISH / FINITION  
**MATRIX**





/  
TRAMA  
**FRASSINO**

MOD.  
**M3-1000**

STIPITE / FRAME / CHAMBRANLE  
**M3-0102 NEW**

FINITURA / FINISH / FINITION  
**FRASSINO / ASH / FRÊNE  
B073**





/  
TRAMA  
**PALISSANDRO BIANCO**

MOD.  
**M3-1000**

STIPITE / FRAME / CHAMBRANLE  
**M3-0102 NEW**

FINITURA / FINISH / FINITION  
**PALISSANDRO BIANCO / WHITE ROSEWOOD / PALISSANDRE BLANC  
2302**





/  
TRAMA  
**PALISSANDRO GRIGIO**

MOD.  
**M3-1000**

STIPITE / FRAME / CHAMBRANLE  
**M3-0102 NEW**

FINITURA / FINISH / FINITION  
**PALISSANDRO GRIGIO / GREY ROSEWOOD / PALISSANDRE GRIS  
LK55**





/  
TRAMA  
**ROVERE**

MOD.  
**M3-1000**

STIPITE / FRAME / CHAMBRANLE  
**M3-0100**

FINITURA / FINISH / FINITION  
**ROVERE / OAK / CHÊNE**  
**LG23**





/  
TRAMA  
**NOCE 840**

MOD.  
**M3-1000**

STIPITE / FRAME / CHAMBRANLE  
**M3-0100**

FINITURA / FINISH / FINITION  
**NOCE / WALNUT / NOYER**  
**840**



/  
TRAMA  
**NOCE 840**

MOD.  
**M3-1201**

STIPITE / FRAME / CHAMBRANLE  
**M3-0100**

FINITURA / FINISH / FINITION  
**NOCE / WALNUT / NOYER**  
**840**



/  
TRAMA  
**ROVERE**

MOD.  
**M3-120E**

STIPITE / FRAME / CHAMBRANLE  
**M3-0100**

FINITURA / FINISH / FINITION  
**ROVERE / OAK / CHÊNE**  
**LG23**



/  
TRAMA  
**NOCE LD57**

MOD.  
**M3-120E**

STIPITE / FRAME / CHAMBRANLE  
**M3-0100**

FINITURA / FINISH / FINITION  
**NOCE / WALNUT / NOYER**  
**LD57**



/  
TRAMA  
**NOCE LD57**

MOD.  
**M3-1000**

STIPITE / FRAME / CHAMBRANLE  
**M3-0100**

FINITURA / FINISH / FINITION  
**NOCE / WALNUT / NOYER**  
**LD57**





/  
TRAMA  
**BIANCO**

MOD.  
**M3-1000**

STIPITE / FRAME / CHAMBRANLE  
**M3-0100**

FINITURA / FINISH / FINITION  
**BIANCO / WHITE / BLANC**  
**B011**



/  
TRAMA  
**CILIEGIO**

MOD.  
**M3-1000**

STIPITE / FRAME / CHAMBRANLE  
**M3-0100**

FINITURA / FINISH / FINITION  
**CILIEGIO / CHERRY / CERISIER**  
**LG69**





/  
TRAMA  
**PALISSANDRO BIANCO**

MOD.  
**M3-2001**

STIPITE / FRAME / CHAMBRANLE  
**M3-0100**

FINITURA / FINISH / FINITION  
**PALISSANDRO BIANCO / WHITE ROSEWOOD / PALISSANDRE BLANC  
2302**



MOD.  
M3-1304

STIPITE / FRAME / CHAMBRANLE  
M3-0100

FINITURA / FINISH / FINITION  
FRASSINO / ASH / FRÊNE  
B073

MOD.  
M3-1000

STIPITE / FRAME / CHAMBRANLE  
M3-0100

FINITURA / FINISH / FINITION  
FRASSINO / ASH / FRÊNE  
B07





## DETTAGLI TECNICI "CONTEMPORANEO"

"CONTEMPORARY" TECHNICAL DETAILS / DÉTAILS TECHNIQUE " CONTEMPORAINE"

### STIPITE M3-0100

FRAME M3-0100  
CHAMBRANLE M3-0100

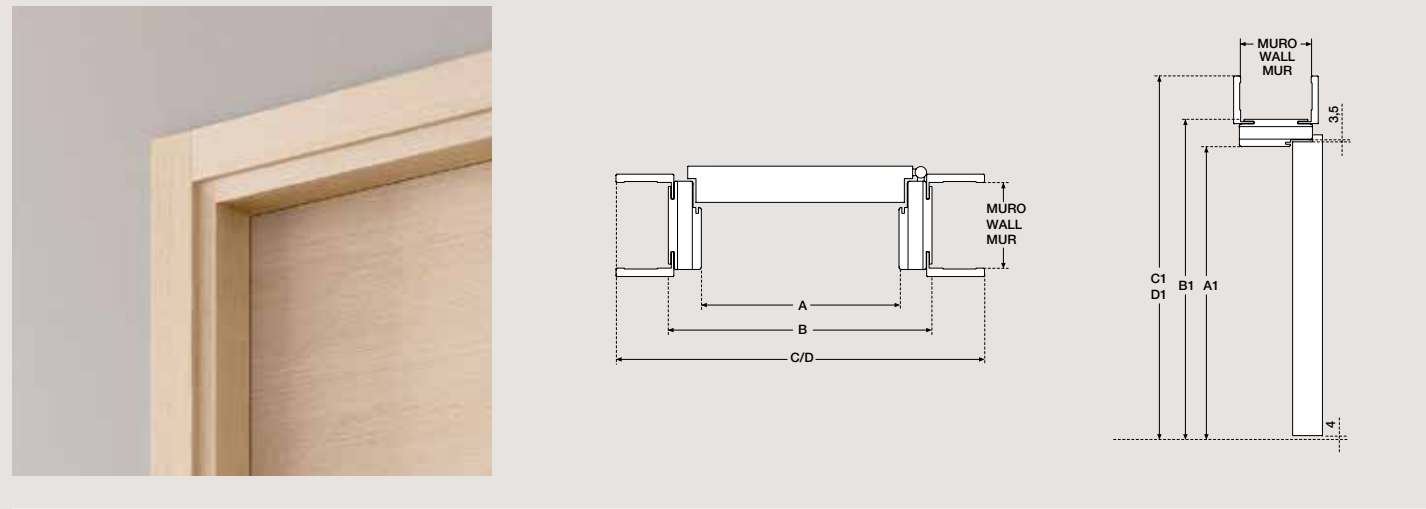

A / A1	B	C	D	B1	C1	D1
Passaggio luce Clear width Net passage	Misura esterno telaio Rough opening Dimension extérieur caïsse	Misura esterno coprifilo 1 External casing 1 Dimension extérieur linteaux 1	Misura esterno coprifilo External casing Dimension extérieur linteaux	Misura esterno telaio Rough opening Dimension extérieur caïsse	Misura esterno coprifilo 1 External casing 1 Dimension extérieur linteaux 1	Misura esterno coprifilo External casing Dimension extérieur linteaux
-	<b>A</b> +80 mm	<b>A</b> +180 mm	<b>A</b> +206 mm	<b>A1</b> +40 mm	<b>A1</b> +90 mm	<b>A1</b> +103 mm

### STIPITE M3-0102 NEW

FRAME M3-0102 NEW  
CHAMBRANLE M3-0102 NEW

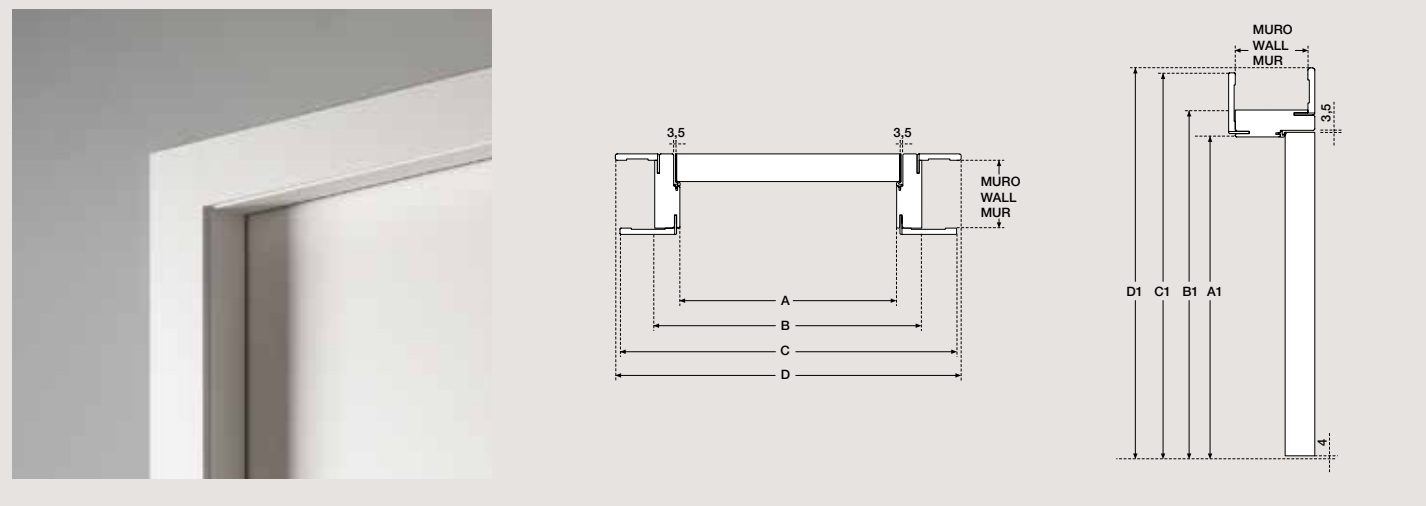

A / A1	B	C	D	B1	C1	D1
Passaggio luce Clear width Net passage	Misura esterno telaio Rough opening Dimension extérieur caïsse	Misura esterno coprifilo 1 External casing 1 Dimension extérieur linteaux 1	Misura esterno coprifilo External casing Dimension extérieur linteaux	Misura esterno telaio Rough opening Dimension extérieur caïsse	Misura esterno coprifilo 1 External casing 1 Dimension extérieur linteaux 1	Misura esterno coprifilo External casing Dimension extérieur linteaux
-	<b>A</b> +80 mm	<b>A</b> +191 mm	<b>A</b> +205 mm	<b>A1</b> +40 mm	<b>A1</b> +95 mm	<b>A1</b> +102 mm

## DETTAGLI TECNICI "CONTEMPORANEO"

"CONTEMPORANEO" TECHNICAL DETAILS / DÉTAILS TECHNIQUE " CONTEMPORAINE"

### CERNIERA ANUBA ANUBA HINGES PAUMELLES ANUBA



### CERNIERA A SCOMPARSA ECLIPSE 2.0 CONCEALED HINGES ECLIPSE 2.0 CHARNIÈRES INVISIBLES ECLIPSE 2.0



# TRASPARENZE

Transparency  
Transparence

/

LUMINOSITÀ, LEGGEREZZA ED ELEGANZA  
RENDONO UNICA E INIMITABILE LA COLLEZIONE  
"TRASPARENZE" DI MOBIL3.

BRIGHTNESS, LIGHTNESS AND ELEGANCE  
MAKE THE MOBIL3 "TRANSPARENCY" COLLECTION  
UNIQUE AND INCOMPARABLE.

LUMINOSITÉ, LÉGÈRETÉ ET ÉLÉGANCE  
RENDENT LA COLLECTION "TRANSPARENCE" DE  
MOBIL3 UNIQUE ET INIMITABLE.

# / M3-WHITE10

MOD.  
**M3-WHITE10**

STIPITE / FRAME / CHAMBRANLE  
**M3-0103**

FINITURA / FINISH / FINITION  
**NORDIC**

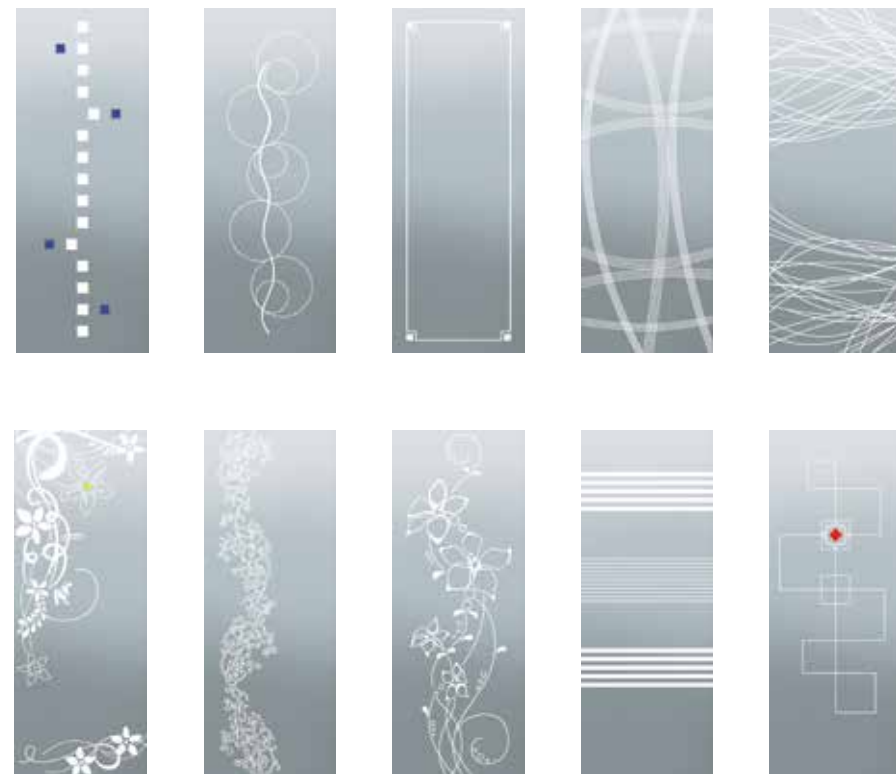



## DETTAGLI TECNICI "TRASPARENZE"

TECHNICAL DETAILS "TRANSPARENCY" / DÉTAILS TECHNIQUES "TRANSPARENCE"

### STIPITE M3-0100

FRAME M3-0100  
CHAMBRANLE M3-0100

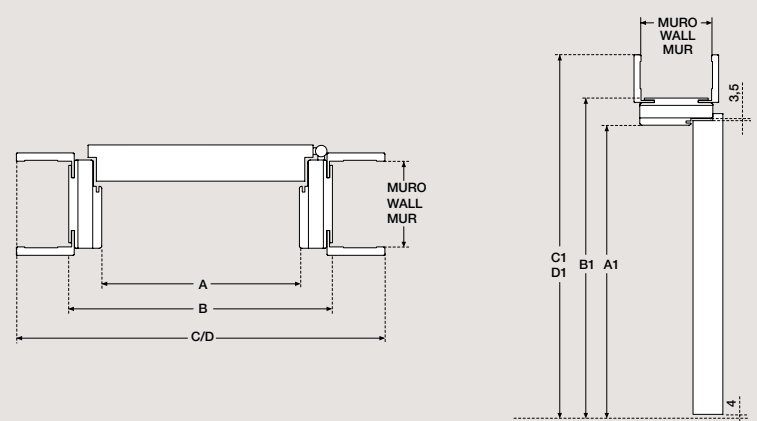

A / A1	B	C / D	B1	C1 / D1
Passaggio luce Width Passage Net passage	Misura esterno telaio External depth frame Dimension extérieur caisse	Misura esterno coprifilo External depth casing Dimension extérieur linteaux	Misura esterno telaio External depth frame Dimension extérieur caisse	Misura esterno coprifilo External depth casing Dimension extérieur linteaux
-	<b>A</b> +80 mm	<b>A</b> +207 mm	<b>A1</b> +80 mm	<b>A1</b> +103 mm

### STIPITE M3-0102 NEW

FRAME M3-0102 NEW  
CHAMBRANLE M3-0102 NEW

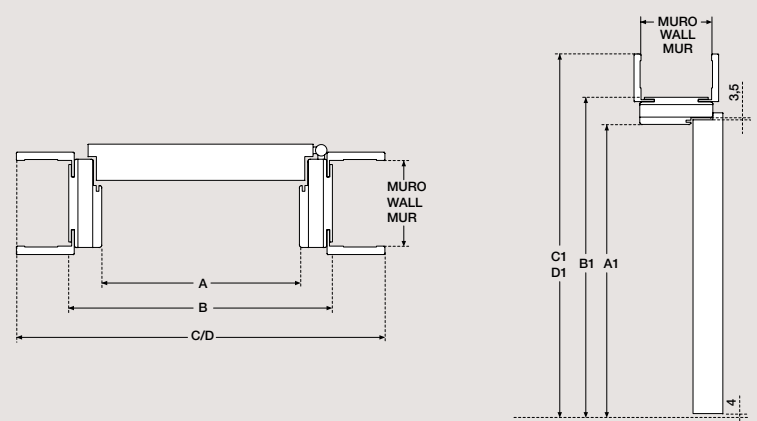

A / A1	B	C	D	B1	C1	D1
Passaggio luce Width Passage Net passage	Misura esterno telaio External depth frame Dimension extérieur caisse	Misura esterno coprifilo 1 External depth casing 1 Dimension extérieur linteaux 1	Misura esterno coprifilo External depth casing Dimension extérieur linteaux	Misura esterno telaio External depth frame Dimension extérieur caisse	Misura esterno coprifilo 1 External depth casing 1 Dimension extérieur linteaux 1	Misura esterno coprifilo External depth casing Dimension extérieur linteaux
-	<b>A</b> +80 mm	<b>A</b> +180 mm	<b>A</b> +206 mm	<b>A1</b> +40 mm	<b>A1</b> +90 mm	<b>A1</b> +103 mm

## DETTAGLI TECNICI "TRASPARENZE"

TECHNICAL DETAILS "TRANSPARENCY" / DÉTAILS TECHNIQUES "TRANSPARENCE"

### STIPITE M3-0103

FRAME M3-0103  
CHAMBRANLE M3-0103

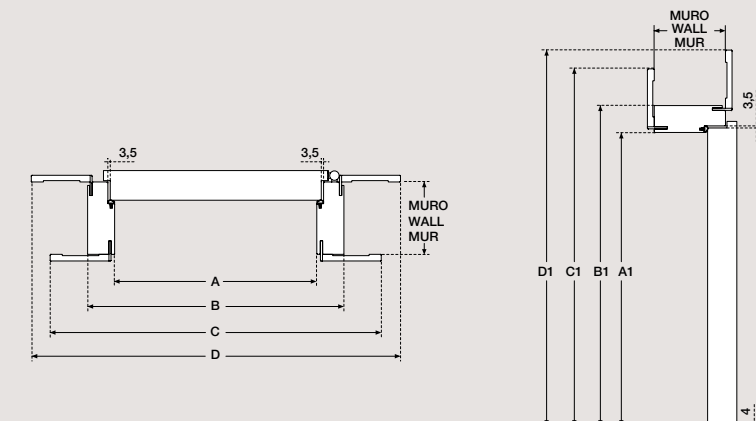

A / A1	B	C	D	B1	C1	D1
Passaggio luce Net dimension Passage Libre	Misura esterno telaio Rough opening Mesure hors cadre	Misura esterno coprifilo 1 External casing 1 À l'extérieur du couvre-joint 1	Misura esterno coprifilo External casing À l'extérieur du couvre-joint	Misura esterno telaio Rough opening Mesure hors cadre	Misura esterno coprifilo 1 External casing 1 À l'extérieur du couvre-joint 1	Misura esterno coprifilo External casing À l'extérieur du couvre-joint
-	<b>A</b> +80 mm	<b>A</b> +190 mm	<b>A</b> +248 mm	<b>A</b> +40 mm	<b>A</b> +95 mm	<b>A1</b> +124 mm

# / FINITURE DELLO STIPITE

FRAME FINISHES / FINITIONS DU CHAMBRANLE

## MATERIA BLANC

MATERIA BLANC  
MATERIA BLANC

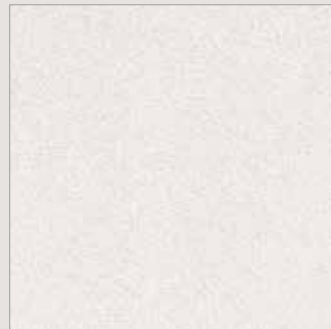

## MATERIA GRIS

MATERIA GRIS  
MATERIA GRIS

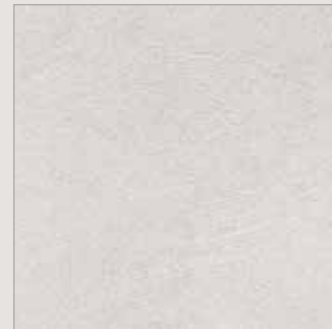

## MATERIA BEIGE

MATERIA BEIGE  
MATERIA BEIGE

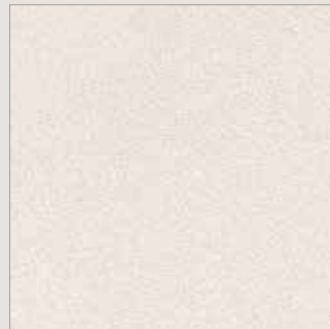

## AMBRA

AMBRA  
AMBRA

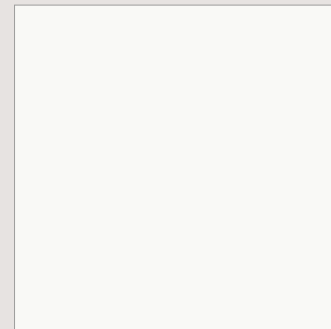

## CANAPA

CANAPA  
CANAPA

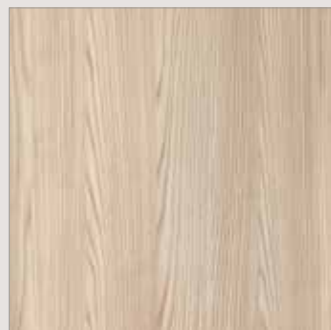

## CORDA

CORDA  
CORDA

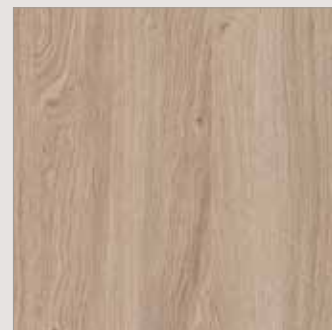

## DAKOTA

DAKOTA  
DAKOTA



## SMOKE

SMOKE  
SMOKE

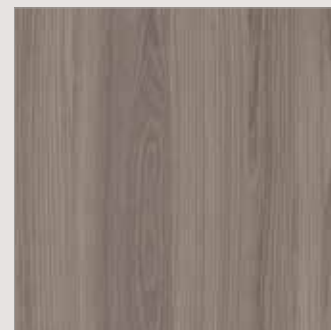

## NORDIC

NORDIC  
NORDIC



## POLAR

POLAR  
POLAR



# / FINITURE DELLO STIPITE

FRAME FINISHES / FINITIONS DU CHAMBRANLE

## BIANCO B011

WHITE B011  
BLANC B011

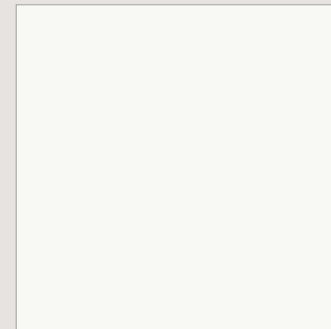

## PANNA B003

CREAM B003  
CRÈME B003

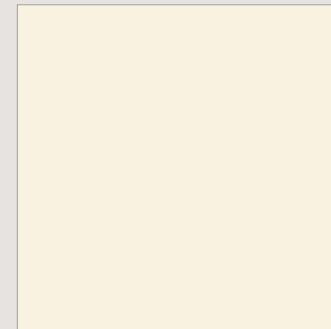

## NOCE LD57

WALNUT LD57  
NOYER LD57

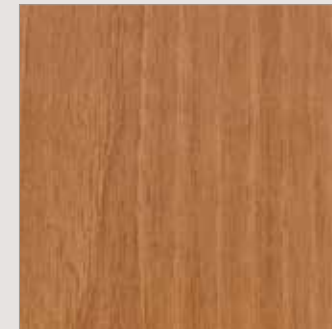

## NOCE 840

WALNUT 840  
NOYER 840

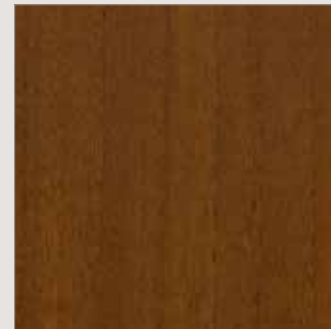

## ROVERE LG23

OAK LG23  
CHÊNE LG23

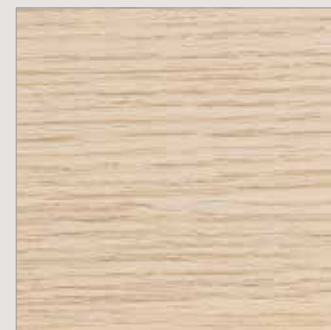

## CILIEGIO LG69

CHERRY LG69  
CERISIER LG69

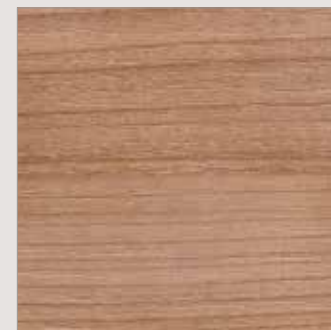

## MATRIX BIANCO B011

MATRIX WHITE B011  
MATRIX BLANC B011

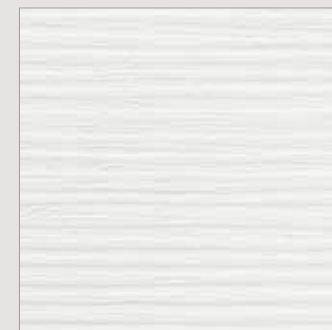

## PALISSANDRO BIANCO 2302

WHITE ROSEWOOD 2302  
PALISSANDRE BLANC 2302



## LARICE GRIGIO 1105

GREY LARCH 1105  
MÉLÈZE GRIS 1105



## GRANO LM36

WHEAT LM36  
BLÉ LM36

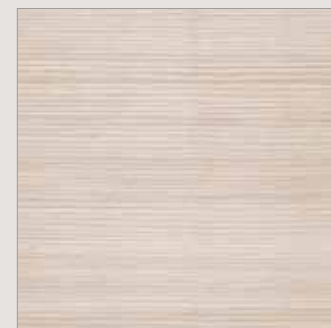

## PALISSANDRO GRIGIO LK55

GREY ROSEWOOD LK55  
PALISSANDRE GRIS LK55



# INVISIBILE

Invisible

Invisible

/

SINTESI DI UN DESIGN MINIMALE, LE PORTE DELLA COLLEZIONE "INVISIBILE" DI MOBIL3 SI INTEGRANO ALLA PERFEZIONE NELLE PARETI, OFFRENDO INTERESSANTI SPUNTI DI ARREDAMENTO.

SYNTHESIS OF A MINIMAL DESIGN, THE DOOR OF MOBIL3 "INVISIBILE" COLLECTION ARE PERFECTLY INTEGRATED INTO THE WALL, OFFERING INTERESTING DECORATING IDEAS.

SYNTHÈSE DU DESIGN MINIMAL, LES PORTES DE LA COLLECTION "INVISIBILE" DE MOBIL3 S'INTÈGRENT À LA PERFECTION DANS LES MURS, EN OFFRANT SOLUTIONS INTÉRESSANTES.



/  
**BASIC 01**

MOD.  
**BASIC01**

STIPITE / FRAME / CHAMBRANLE  
**M3-0300**

FINITURA / FINISH / FINITION  
**MATERIA BEIGE**

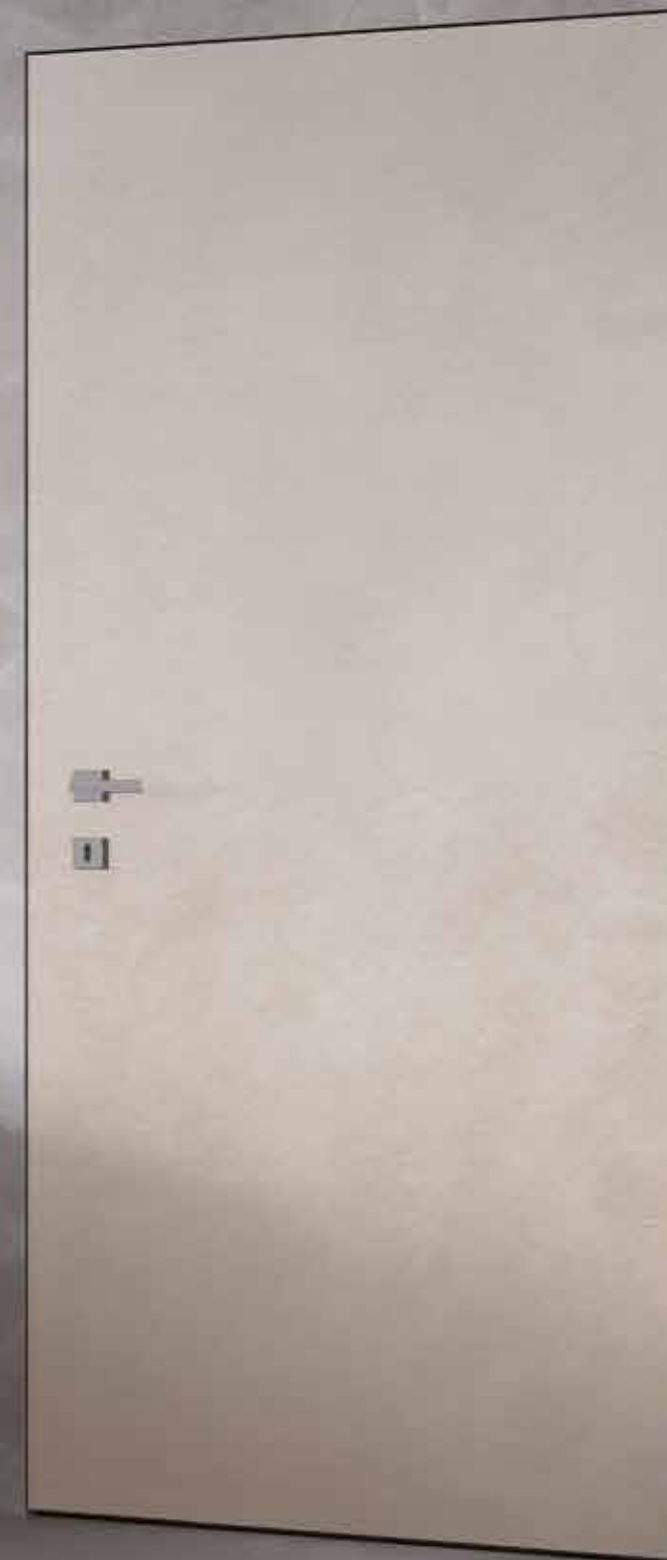



/  
INVISIBILE  
**INTONACO**

APERTURA A LIBRO / FOLDING OPENING /  
PLIANTE

MOD.  
**M3-BASIC01**

STIPITE / FRAME / CHAMBRANLE  
**M3-0300**

FINITURA / FINISH / FINITION  
**INTONACO / PLASTER / PLÂTRE**

## DETTAGLI TECNICI "INVISIBILE"

"INVISIBLE" TECHNICAL DETAILS / DÉTAILS TECHNIQUES "INVISIBILE"

### STIPITE M3-0300

FRAME M3-0300  
CHAMBRANLE M3-0300

#### APERTURA A SPINGERE / PUSH OPENING / OUVERTURE À POUSSER

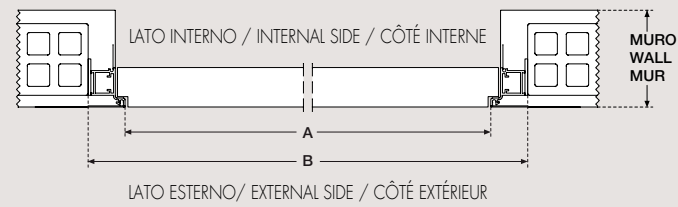

#### APERTURA A TIRARE / PULL OPENING / OUVERTURE À TIRER

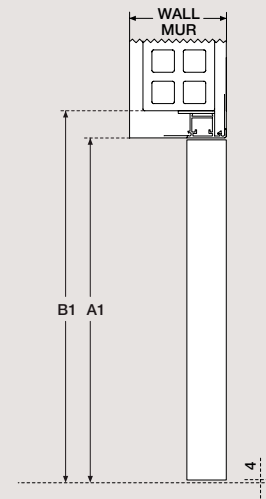
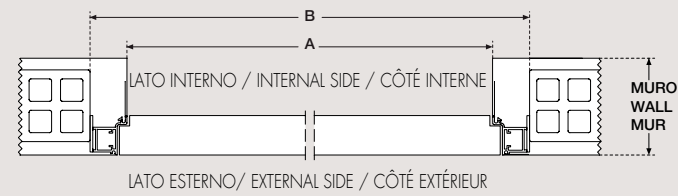

#### A / A1

Passaggio luce  
Width Passage  
Net passage

#### B

Misura esterno telaio  
External depth frame  
Dimension extérieur caisse

A +80 mm

#### B1

Misura esterno telaio  
External depth frame  
Dimension extérieur caisse

A1 +50 mm

### STIPITE M3-0301

FRAME M3-0301  
CHAMBRANLE M3-0301

#### APERTURA A SPINGERE / PUSH OPENING / OUVERTURE À POUSSER

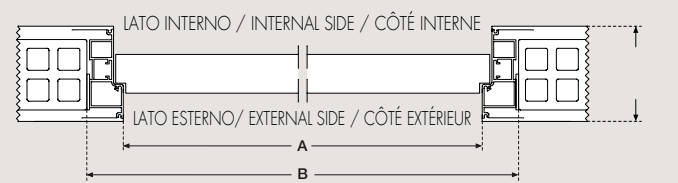

#### APERTURA A TIRARE / PULL OPENING / OUVERTURE À TIRER

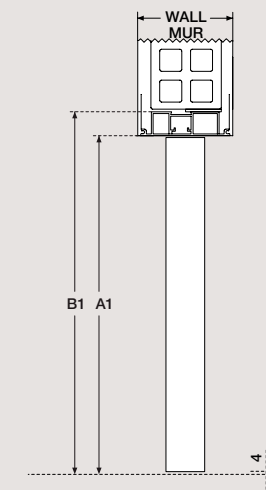
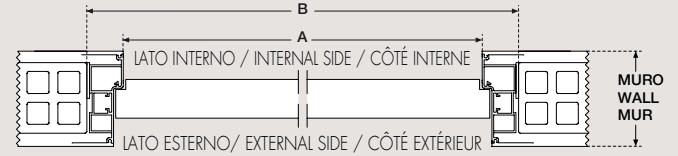

#### A / A1

Passaggio luce  
Width Passage  
Net passage

#### B

Misura esterno telaio  
External depth frame  
Dimension extérieur caisse

A +80 mm

#### B1

Misura esterno telaio  
External depth frame  
Dimension extérieur caisse

A1 +50 mm

## DETTAGLI TECNICI "INVISIBILE"

"INVISIBLE" TECHNICAL DETAILS / DÉTAILS TECHNIQUES "INVISIBILE"

### CERNIERA A SCOMPARSA K1000

CONCEALED HINGES K1000  
CHARNIÈRES INVISIBLES K1000





/  
**FINITURE**

FINISHES / FINITIONS

**MATERIA BLANC**

MATERIA BLANC  
MATERIA BLANC

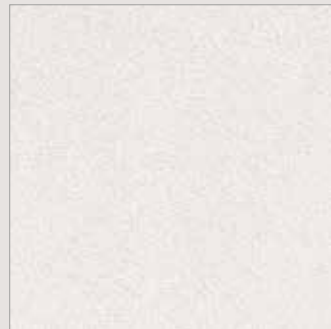

**MATERIA GRIS**

MATERIA GRIS  
MATERIA GRIS



**MATERIA BEIGE**

MATERIA BEIGE  
MATERIA BEIGE

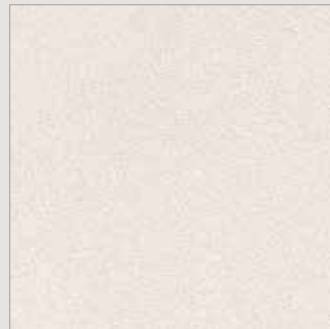

**AMBRA**

AMBRA  
AMBRA

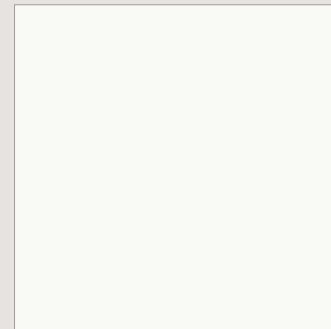

**BIANCO B011**

WHITE B011  
BLANC B011

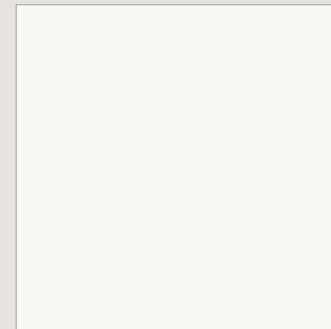

**PANNA B003**

CREAM B003  
CRÈME B003

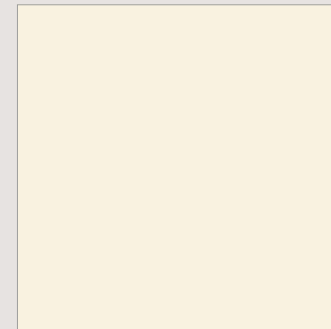

**NOCE LD57**

WALNUT LD57  
NOYER LD57

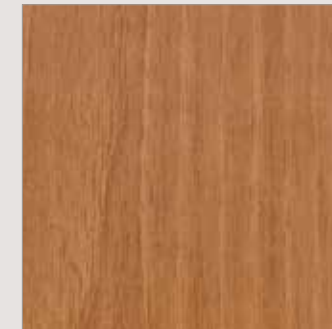

**NOCE 840**

WALNUT 840  
NOYER 840

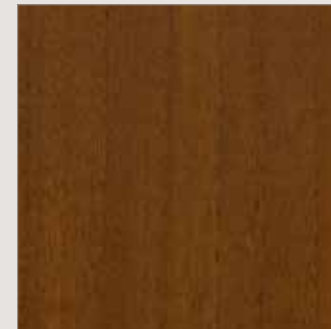

**CANAPA**

CANAPA  
CANAPA



**CANAPA ORTHOGONAL**

CANAPA ORTHOGONAL  
CANAPA ORTHOGONAL

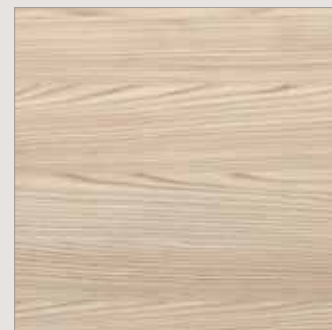

**CORDA**

CORDA  
CORDA



**DAKOTA**

DAKOTA  
DAKOTA

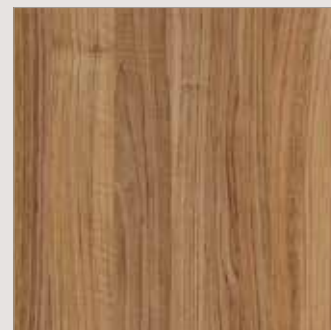

**ROVERE LG23**

OAK LG23  
CHÊNE LG23

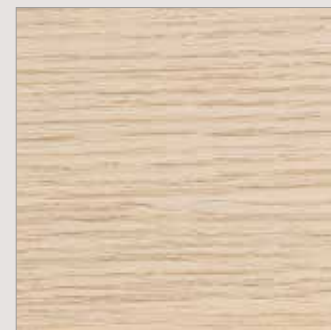

**CILIEGIO LG69**

CHERRY LG69  
CERISIER LG69

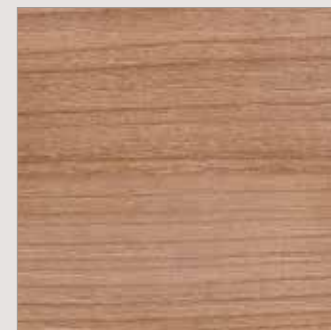

**MATRIX BIANCO B011**

MATRIX WHITE B011  
MATRIX BLANC B011

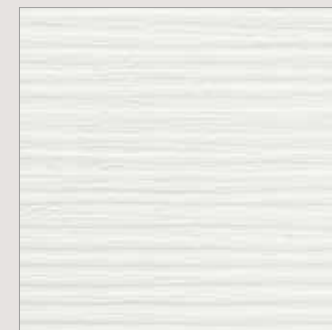

**PALISSANDRO BIANCO 2302**

WHITE ROSEWOOD 2302  
PALISSANDRE BLANC 2302



**SMOKE**

SMOKE  
SMOKE



**NORDIC**

NORDIC  
NORDIC



**POLAR**

POLAR  
POLAR



**POLAR ORTHOGONAL**

POLAR ORTHOGONAL  
POLAR ORTHOGONAL

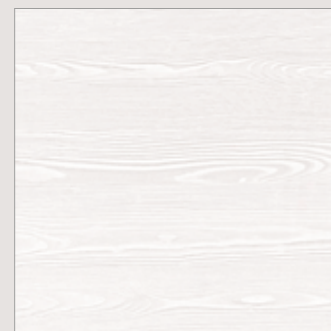

**FRASSINO B073**

ASH B073  
FRÊNE B073

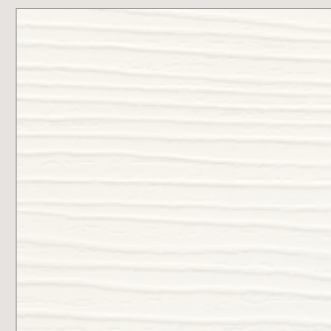

**LARICE GRIGIO 1105**

GREY LARCH 1105  
MÊLÈZE GRIS 1105



**GRANO LM36**

WHEAT LM36  
BLÉ LM36

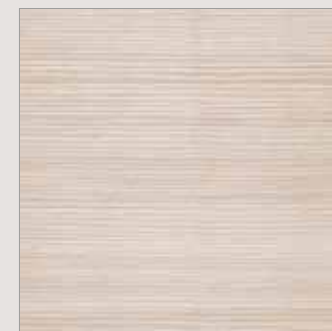

**PALISSANDRO GRIGIO LK55**

GREY ROSEWOOD LK55  
PALISSANDRE GRIS LK55



# SOLUZIONI DI APERTURA

Opening solutions  
Solutions d'ouverture

/

SOBRIA ELEGANZA E FONDAMENTALE PRATICITÀ.  
SOLUZIONI PER OGNI ESIGENZA.

SIMPLE ELEGANCE AND PRACTICALITY.  
SOLUTIONS FOR ALL TASTES.

ÉLÉGANCE DISCRÈTE ET PRAGMATISME.  
DES SOLUTIONS POUR CHAQUE BESOIN.



/  
**SCORREVOLE IN LUCE**  
**2 ANTE PARALLELE**

BYPASS DOOR

COULISSANTE À 2  
VANTAUX PARALLÈLES



/  
**SCORREVOLE  
INTERNO MURO**

POCKET DOOR

PORTE COULISSANTE  
À GALANDAGE





/  
**SCORREVOLE ESTERNO  
MURO - TIPO "A"**

EXTERNAL SLIDING  
DOOR - TYPE "A"

PORTE EN APPLIQUE -  
TYPE "A"



/  
**PORTA A LIBRO**  
**1/3 + 2/3**

FOLDING DOOR  
1/3 + 2/3

PORTE PLIANTE  
1/3 + 2/3







/  
**ROTOTRASLANTE**  
PIVOT DOOR  
PORTE PIVOTANTE

/  
**PORTA A LIBRO  
SIMMETRICA**

SYMMETRICAL  
FOLDING DOOR

PORTE PLIANTE  
SYMÉTRIQUE



# VETRI

Glasses  
Verres





M3-01

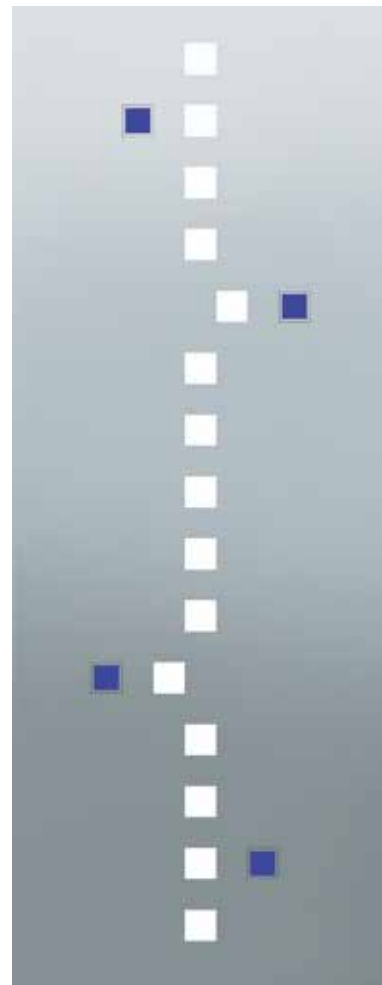

M3-02



M3-03



M3-04

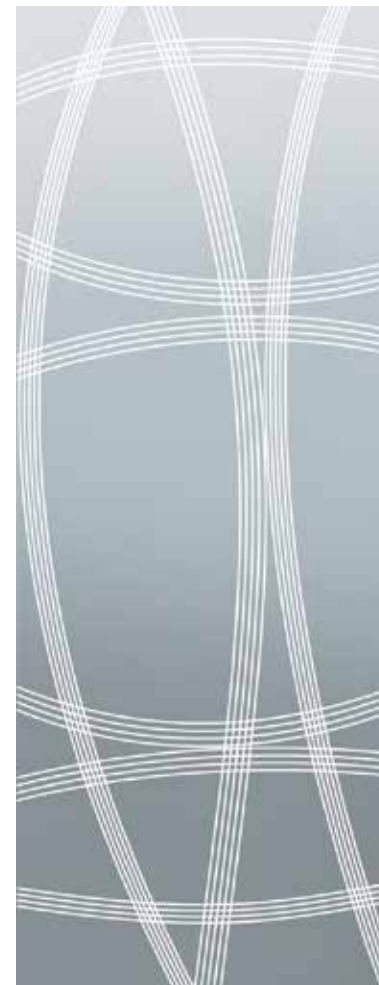

M3-05

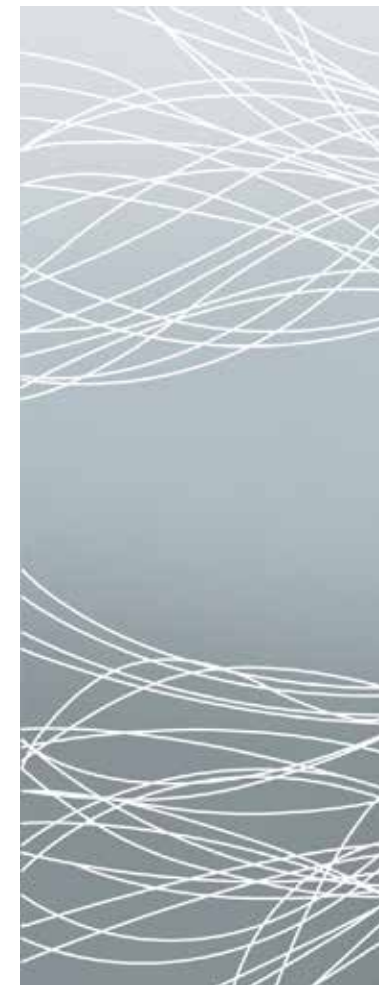

M3-06



M3-07



M3-08



M3-09

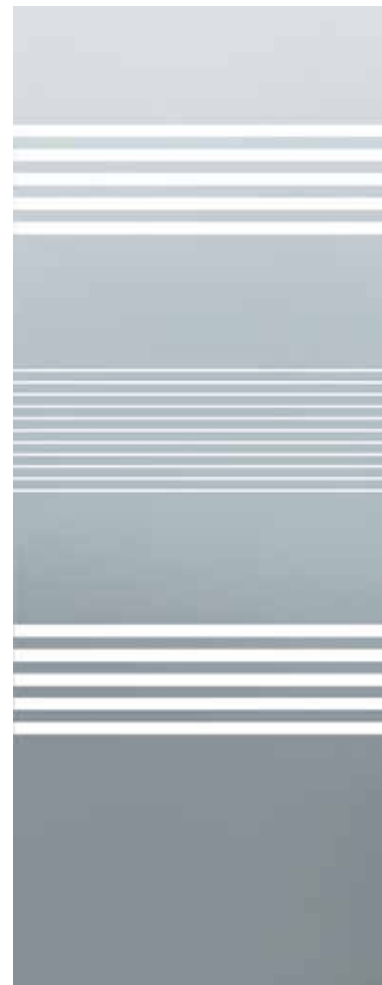

M3-10

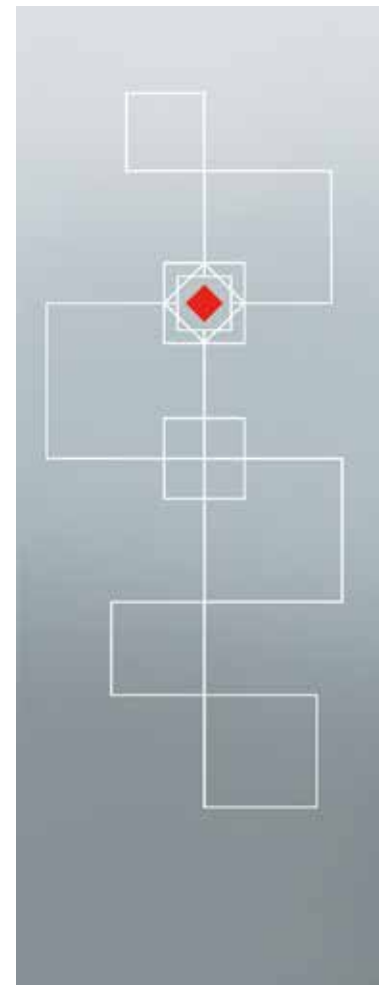

S-305



S-401



**VETRI**

GLASSES / VERRES

**VETRI**

GLASSES / VERRES

**S-403**



**SR-001**

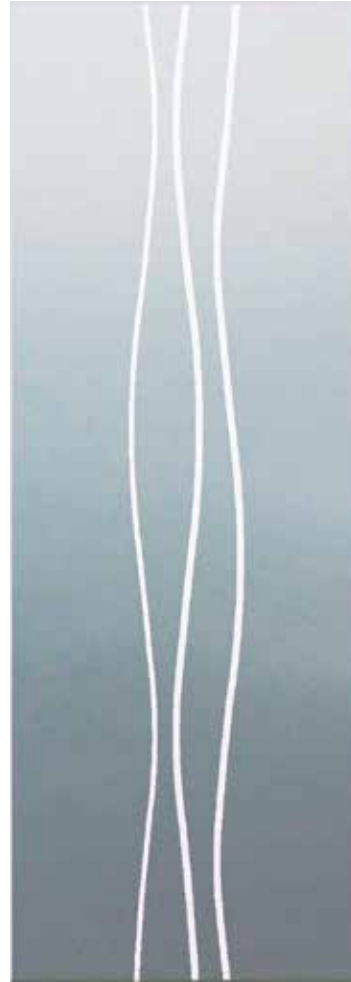

**SF-103**



**SR-008**



**SR-righe**  
SR-lines  
SR-lignes

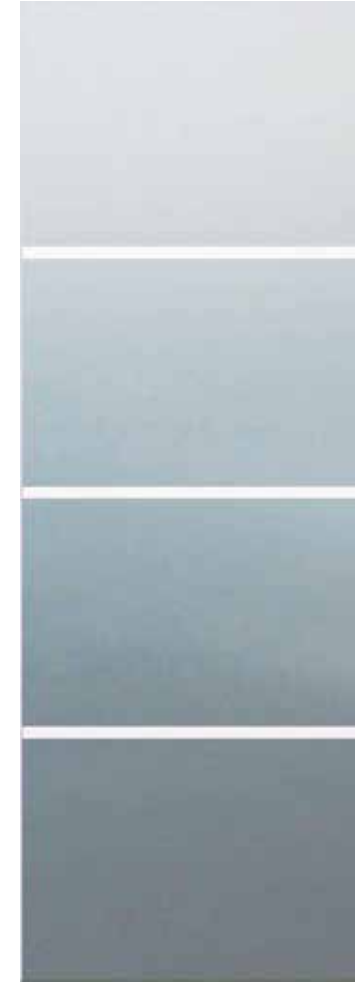

**Satinato**  
White frosted  
Dépoli blanc





**D014**



**D015**



**D087**



**D020**



**D163**



# MANIGLIE

Handles  
Poignée



**MANIGLIE**  
HANDLES / POIGNÉE

Finitura ottone lucido - Polished brass - Laiton poli

**MANIGLIE CON ROSETTE TONDE**  
HANDLES WITH ROUND ROSETTES  
POIGNÉES AVEC ROSACE RONDE

**MANIGLIA SABINA**  
SABINA HANDLE  
POIGNÉE SABINA



**MANIGLIA ALISÈ**  
ALISÈ HANDLE  
POIGNÉE ALISÈ



**MANIGLIA SASHA**  
SASHA HANDLE  
POIGNÉE SASHA



**MANIGLIA MILLA**  
MILLA HANDLE  
POIGNÉE MILLA



**MANIGLIA TENDER**  
TENDER HANDLE  
POIGNÉE TENDER



**MANIGLIE**  
HANDLES / POIGNÉE

Finitura cromo satinato - Satin chrome - Chrome satiné

**MANIGLIE CON ROSETTE TONDE**  
HANDLES WITH ROUND ROSETTES  
POIGNÉES AVEC ROSACE RONDE

**MANIGLIA HAITI**  
HAITI HANDLE  
POIGNÉE HAITI



**MANIGLIA EVEREST**  
EVEREST HANDLE  
POIGNÉE EVEREST



**MANIGLIA SABINA**  
SABINA HANDLE  
POIGNÉE SABINA



**MANIGLIA ALISÈ**  
ALISÈ HANDLE  
POIGNÉE ALISÈ



**MANIGLIA SASHA**  
SASHA HANDLE  
POIGNÉE SASHA



**MANIGLIA MILLA**  
MILLA HANDLE  
POIGNÉE MILLA



**MANIGLIA TENDER**  
TENDER HANDLE  
POIGNÉE TENDER





**MANIGLIE**  
HANDLES / POIGNÉE

Finitura cromo satinato - Satin chrome - Chrome satiné

**MANIGLIE CON ROSETTE QUADRE**  
HANDLES WITH SQUARE ROSETTES  
POIGNÉES AVEC ROSACE CARRÉE

**MANIGLIA ACAPULCO**  
ACAPULCO HANDLE  
POIGNÉE ACAPULCO



**MANIGLIA Q-MINI**  
Q-MINI HANDLE  
POIGNÉE Q-MINI



**MANIGLIA SPRING**  
SPRING HANDLE  
POIGNÉE SPRING



**MANIGLIA ZELDA**  
ZELDA HANDLE  
POIGNÉE ZELDA

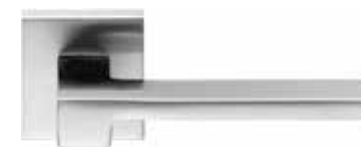

**MANIGLIA ROBOS S**  
ROBOS S HANDLE  
POIGNÉE ROBOS S



**MANIGLIA ELLESSE**  
ELLESSE HANDLE  
POIGNÉE ELLESSE



**MANIGLIA IXIA**  
IXIA HANDLE  
POIGNÉE IXIA



**MANIGLIA B-MINI**  
B-MINI HANDLE  
POIGNÉE B-MINI



**MANIGLIA Q-LINE**  
Q-LINE HANDLE  
POIGNÉE Q-LINE



Finitura nero opaco - Matt black - Noir mat

**MANIGLIE CON ROSETTE QUADRE**  
HANDLES WITH SQUARE ROSETTES  
POIGNÉES AVEC ROSACE CARRÉE

**MANIGLIA Q-10**  
Q-10 HANDLE  
POIGNÉE Q-10



**MANIGLIA ALBA**  
ALBA HANDLE  
POIGNÉE ALBA



**MANIGLIA DEA**  
DEA HANDLE  
POIGNÉE DEA



**MANIGLIA Q-MINI**  
Q-MINI HANDLE  
POIGNÉE Q-MINI



**MANIGLIA ROBOS S**  
ROBOS S HANDLE  
POIGNÉE ROBOS S



**MANIGLIETTE PER PORTE SCORREVOLI**  
HANDLES FOR SLIDING DOORS  
KIT POIGNÉE POUR PORTES COULISSANTES

**MT - MANIGLIETTA TONDA CIECA**  
MT ROUND BLIND HANDLE  
MT - KIT COQUILLE ROND



**MST - NOTTOLINO L/O TONDO**  
MST - ROUND CATCHES  
MST - KIT CROCHET ROND



**NOTTOLINI L/O PER PORTE BATTENTI**  
TOILET KNOB FOR HINGED DOORS  
CROCHET POUR PORTES BATTENTES

**NOTTOLINO TONDO**  
ROUND KNOB  
CROCHET ROND



**NOTTOLINO QUADRO**  
SQUARE KNOB  
CROCHET CARRÉ

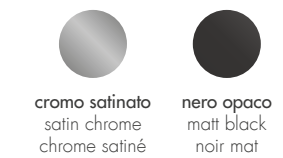

**MT - MANIGLIETTA QUADRA CIECA**  
MT SQUARE BLIND HANDLE  
MT - KIT COQUILLE CARRÉ

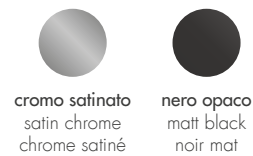

**MST - NOTTOLINO L/O QUADRO**  
MST - SQUARE CATCHES  
MST - KIT CROCHET CARRÉ

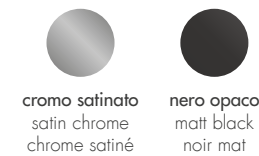

Le porte vengono fornite senza il ditale; il trascinato avviene tramite il tiretto posizionato nella parte inferiore della piastra della serratura.  
Doors do not include the thimble strike; the door slides by using the pull out lever placed in the lock forend.  
Le kit poignée n'inclut pas le doigt de traîne; la porte coulisse grâce au levier dans la partie inférieure du kit poignée.

Finitura cromo satinato - Satin chrome - Chrome satiné

**MANIGLIONI**

BARS  
POIGNÉE BÂTON DE MARÉCHAL

**MANIGLIONE FRANKFURT**  
FRANKFURT BAR  
POIGNÉE FRANKFURT



**MANIGLIONE TORONTO**  
TORONTO BAR  
BARRE TORONTO

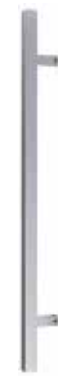

**MANIGLIA ELETTRONICA**

ELECTRONIC HANDLE  
POIGNÉE ELECTRONIQUE



**Ne facciamo di tutti i colori**

We are up to all sorts of things...and colors. / Nous faisons toutes les couleurs!

MOOD COLLECTION DI COLOMBO DESIGN DÀ SPAZIO AL COLORE E ALLA CREATIVITÀ. UN NUOVO MODO DI PRESENTARE E INTERPRETARE LA MANIGLIA. MOOD COLLECTION. MOLTO PIÙ DI UNA COLLEZIONE.

Colombo Design's Mood Collection gives space to color and creativity. A new way of presenting and conceiving the handle. Mood Collection. Much more than a collection. / La Collection Mood de Colombo Design fait place à la couleur et à la créativité. Une nouvelle façon de présenter et d'interpréter la poignée. Collection Mood. Bien plus qu'une Collection.



A disposizione una gamma di 12 colori, accuratamente selezionati per poter definire il mood di una stanza.

A range of 12 colors is available, carefully selected to define the mood of each space. / Disponible en 12 couleurs soigneusement sélectionnées pour définir l'ambiance de chaque espace.  
**white / ocean blue / silver / bronze / sunset orange / lemon yellow / lime green / titan / black / claret violet / strawberry red / capri blue**

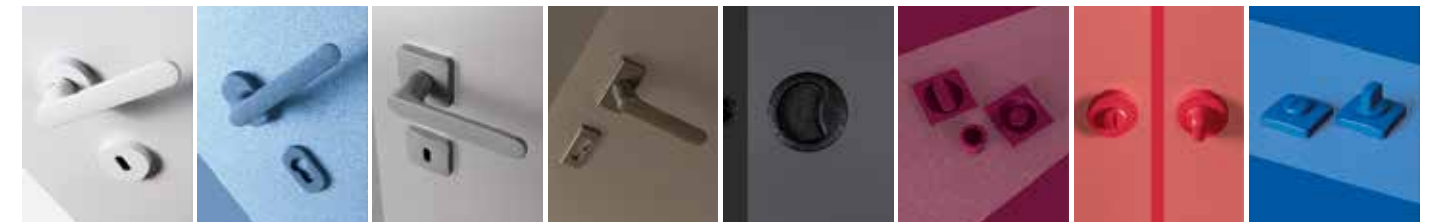

"ONE" E "ONEQ"  
POSSONO ESSERE  
REALIZZATE IN TUTTI I COLORI RAL.  
NESSUN LIMITE ALLA CREATIVITÀ!

"ONE" AND "ONEQ"  
CAN BE CUSTOMIZED  
IN ALL RAL COLOR VARIANTS.  
THERE IS NO LIMIT TO CREATIVITY!

LES POIGNÉE "ONE" ET "ONEQ"  
PEUVENT ÊTRE RÉALISÉES  
DANS TOUTES LES COULEURS RAL.  
IL N'Y A AUCUNE LIMITE À LA CREATIVITÉ!



# MANIGLIE

HANDLES / POIGNÉE



## MANIGLIE CON ROSETTE TONDE

HANDLES WITH ROUND ROSETTES  
POIGNÉES AVEC ROSACE RONDE

### MANIGLIA COLOMBO ONE

COLOMBO ONE HANDLE  
POIGNÉE COLOMBO ONE



## MANIGLIE CON ROSETTE QUADRE

HANDLES WITH SQUARE ROSETTES  
POIGNÉES AVEC ROSACE CARRÉE

### MANIGLIA COLOMBO ONE Q

COLOMBO ONE Q HANDLE  
POIGNÉE COLOMBO ONE Q



## NOTTOLINI L/O PER PORTE BATTENTI

TOILET KNOB FOR HINGED DOORS  
CROCHET POUR PORTES BATTENTES

### NOTTOLINO TONDO

ROUND KNOB  
CROCHET ROND



### NOTTOLINO QUADRO

SQUARE KNOB  
CROCHET CARRÉ



# MANIGLIE

HANDLES / POIGNÉE

Finitura ral - ral - ral

## MANIGLIETTE TONDE PER PORTE SCORREVOLI

ROUND HANDLES FOR SLIDING DOORS  
KIT POIGNÉE ROND POUR PORTES COULISSANTES

### MT - MANIGLIETTA TONDA CIECA

MT ROUND BLIND HANDLE  
MT - KIT COQUILLE ROND



### MST - NOTTOLINO L/O TONDO

MST - ROUND CATCHES  
MST - KIT CROCHET ROND



## MANIGLIETTE QUADRE PER PORTE SCORREVOLI

SQUARE HANDLES FOR SLIDING DOORS  
KIT POIGNÉE CARRÉ POUR PORTES COULISSANTES

### MT - MANIGLIETTA QUADRA CIECA

MT SQUARE BLIND HANDLE  
MT - KIT COQUILLE CARRÉ

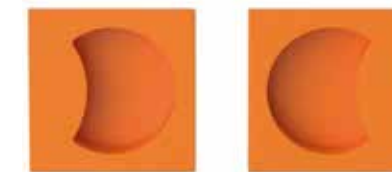

### MST - NOTTOLINO L/O QUADRO

MST - SQUARE CATCHES  
MST - KIT CROCHET CARRÉ

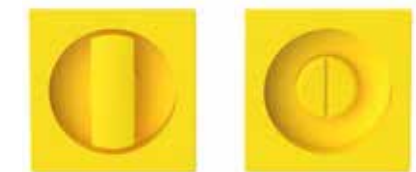

**project & graphic design**  
www.lithos.it

**3d rendered images**  
www.linkfoto.it

**print**  
grafiche Italprint

edition 2023



**MOBIL3 S.R.L.**  
Via G. Galilei, 3  
30020 Torre di Mosto, VE, ITALY  
T. +39 0421 461833 - F. +39 0421 314207  
info@mobil3srl.com  
[www.mobil3srl.com](http://www.mobil3srl.com)

TUTTI I DIRITTI DI RIPRODUZIONE E  
RIELABORAZIONE SONO RISERVATI.  
MOBIL3 SRL SI RISERVA DI APPORTARE  
MODIFICHE, ANCHE SENZA PREAV-  
VISO ED IN QUALSIASI MOMENTO,  
ALLE CARATTERISTICHE DEI PRODOTTI  
RIPORTATI NEL PRESENTE CATALOGO.

I COLORI DELLE PORTE RIPRODOTTE  
NEL PRESENTE CATALOGO SONO  
PURAMENTE INDICATIVI.

All rights reserved, including reprint and  
rework. Mobil3 Ltd reserves the right to  
modify the characteristics of products  
listed in this catalogue without prior noti-  
ce. The image is intended for illustration  
purposes only and be different from the  
actual colours due to the limitations of  
print technology.



**MOBIL3 S.R.L.**

Via G. Galilei, 3

30020 Torre di Mosto, VE, ITALY

T. +39 0421 461833 - F. +39 0421 314207

[www.mobil3srl.com](http://www.mobil3srl.com) - [info@mobil3srl.com](mailto:info@mobil3srl.com)